

PART NO.	A	B	C
040HR-69C	31.4	28.0	27.2
040HR-81C	36.2	32.8	32.0

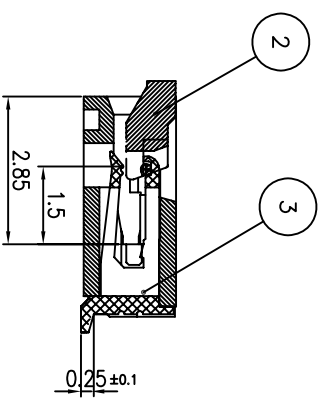

SEC A - A"

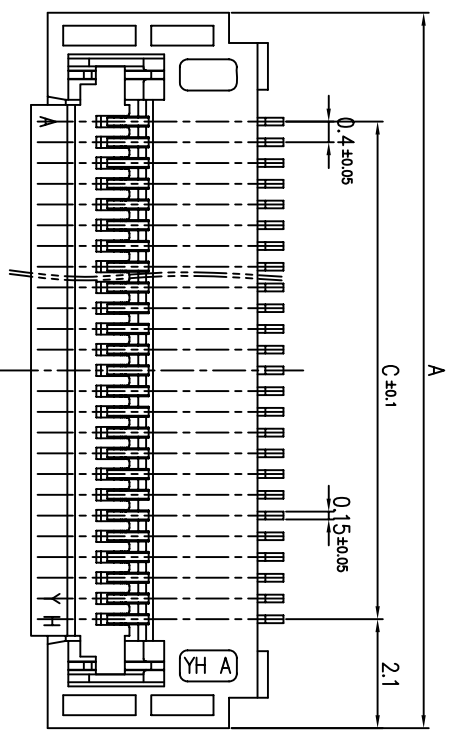
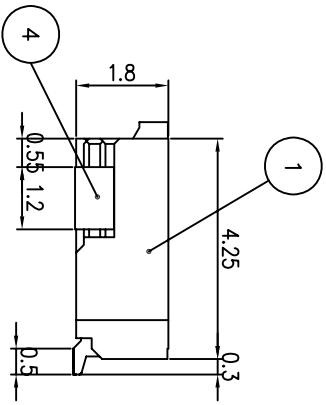
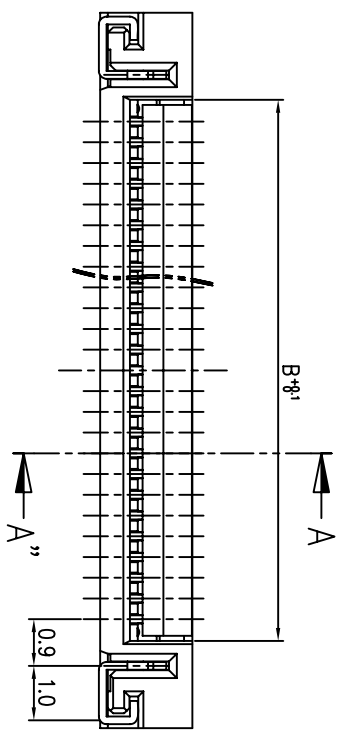
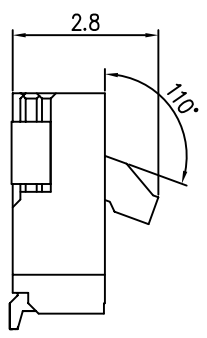

NOTE  
 1. GENERAL TOLERANCE ±0.2  
 2. MATCHING PARTS.  
 - HOUSING : 040HR-NNC  
 - TERMINAL : 040TR-C  
 - ACTUATOR : 040AS-NNC  
 - HOOK : 05002LR-F

<b>YEONHO ELECTRONICS CO., LTD.</b>		<b>040HR-NNC</b>	
SCALE	DRAWN	DESIGN	CHECK
10/1			
REVISION RECORD		DATE	DR
LTR			CHK
"본 도면은 영호전자사의 지적재산이므로 임의의 COPY 및 배포를 금합니다"			

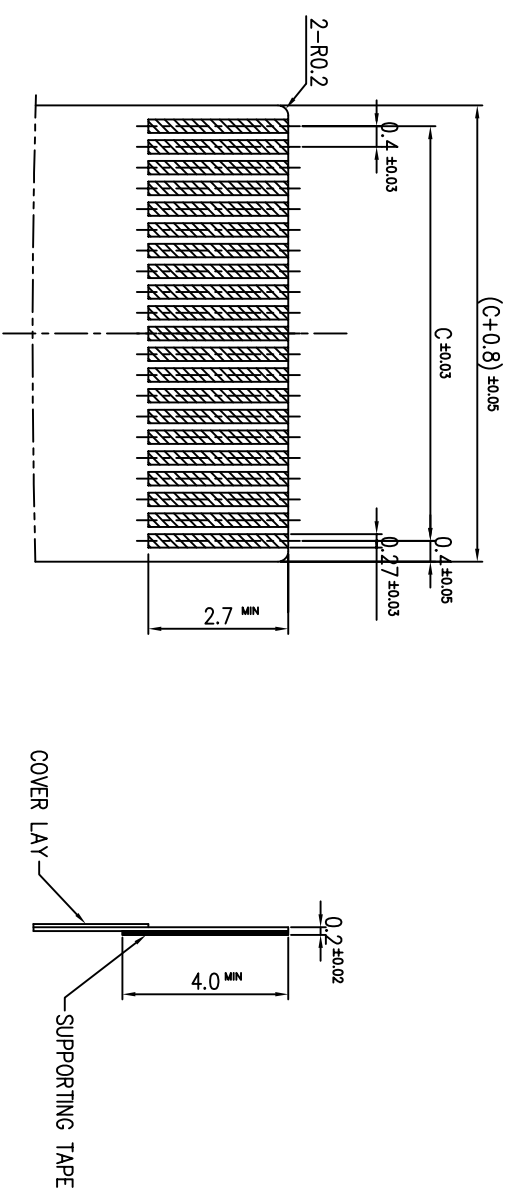

APPLICABLE FPC

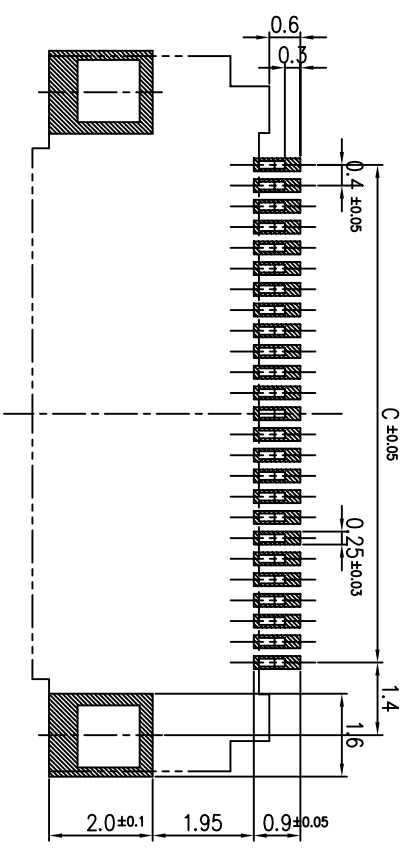

PCB LAYOUT

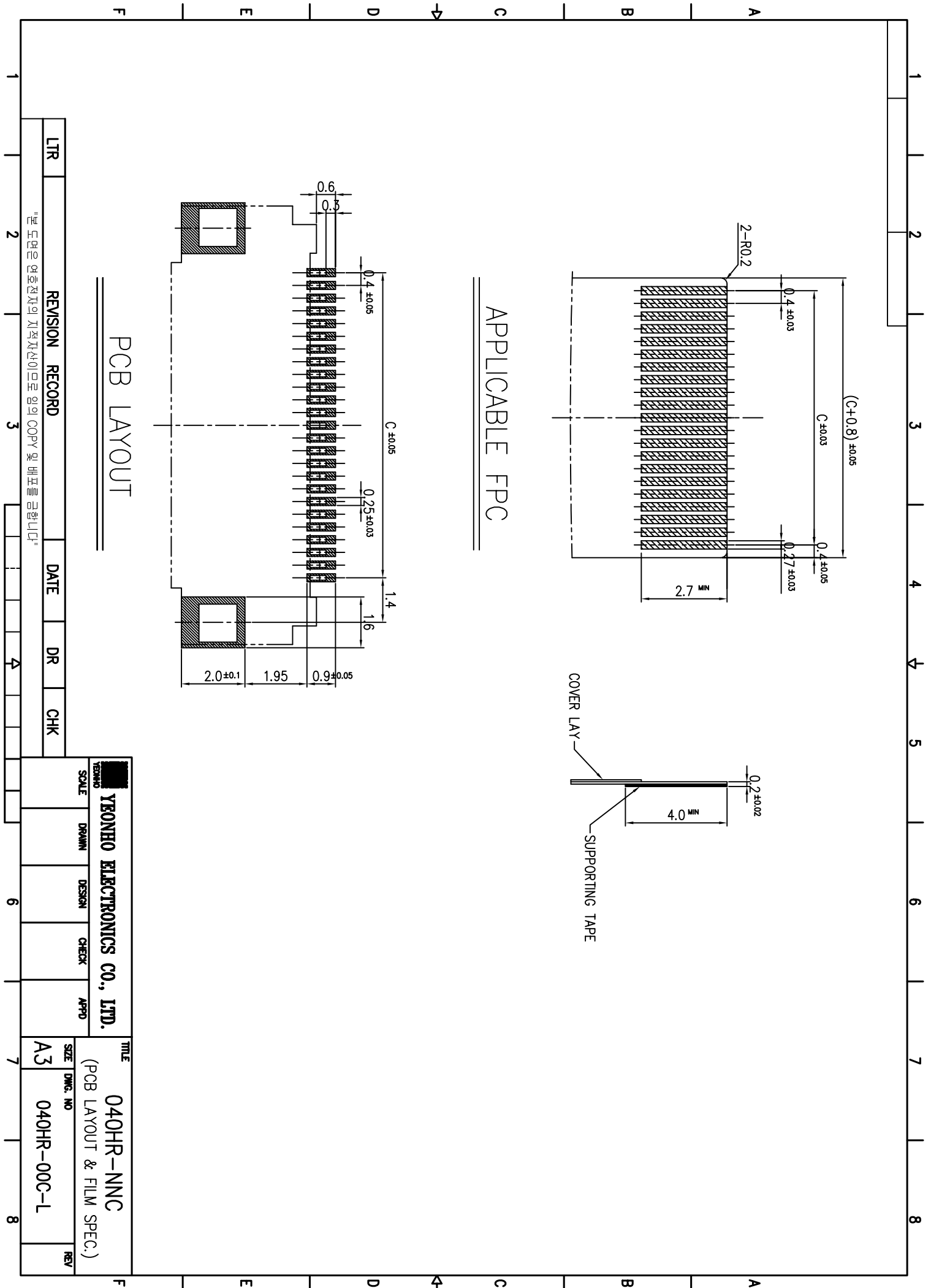

LTR	REVISION	RECORD	DATE	DR	CHK
2					

"본 도면은 अनु전자의 지적재산이므로 임의의 COPY 및 배포를 금합니다"

<b>YEONHO ELECTRONICS CO., LTD.</b> (PCB LAYOUT & FILM SPEC.)		<b>TITLE</b> 040HR-NNC	
SCALE	DRAWN	DESIGN	CHECK
APPRO	SIZE	DWG. NO	REV
	A3	040HR-00C-L	